

Frog

Designed by: Won Park
Diagrammed by: Márcio Noguchi

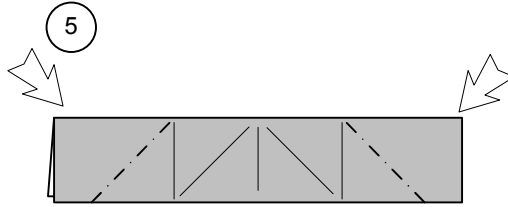

Inside reverse fold

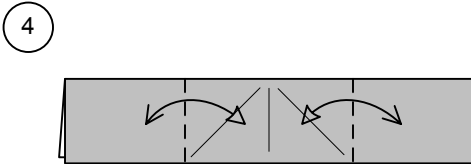
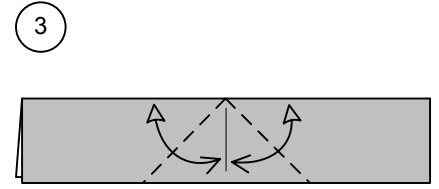
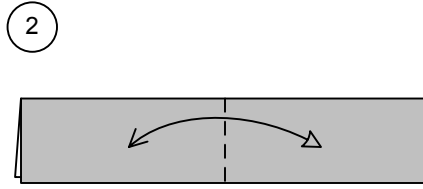
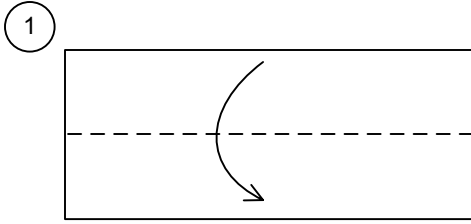
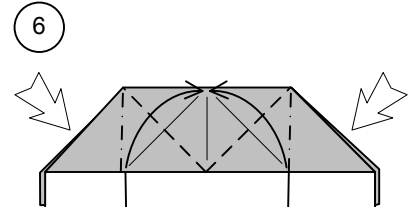

Squash fold
top layer only.

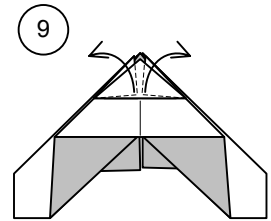
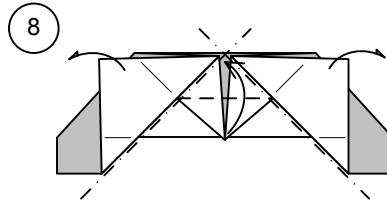
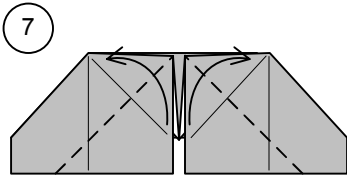

Pull out hidden flaps

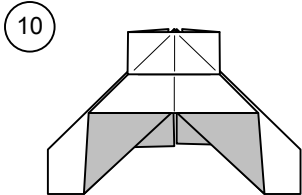

Turn over

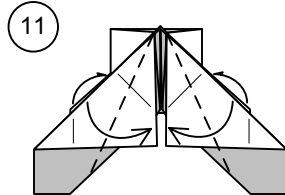

Outside reverse fold. (You may have to partially open the mode)

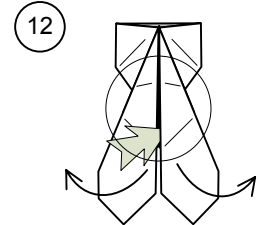

Open to view inside

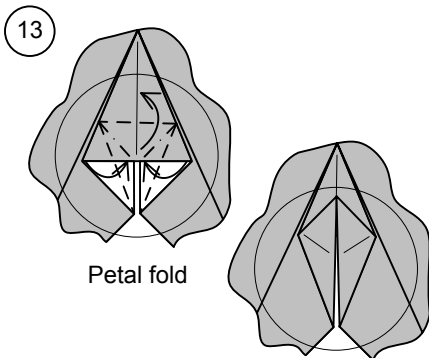

Petal fold

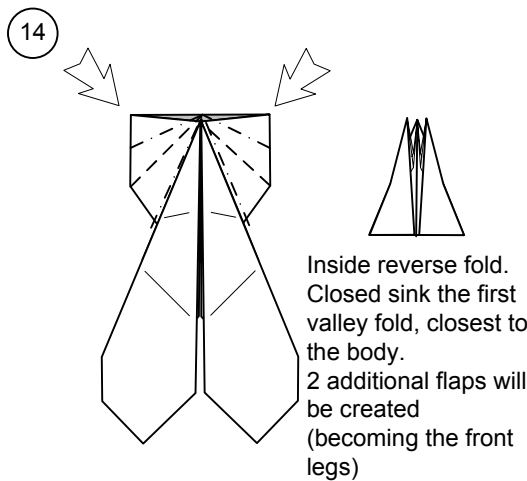

Inside reverse fold. Closed sink the first valley fold, closest to the body. 2 additional flaps will be created (becoming the front legs)

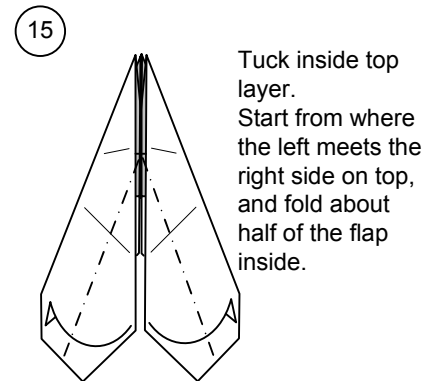

Tuck inside top layer. Start from where the left meets the right side on top, and fold about half of the flap inside.

16

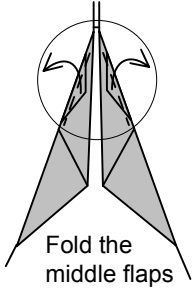
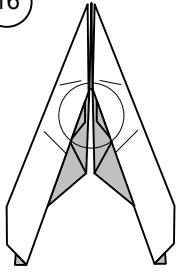

Fold the middle flaps inside the "legs" created in step 15.

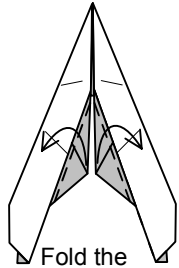

Fold the bottom flaps inside the "legs" created in step 15.

17

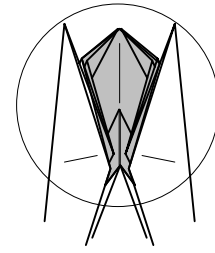
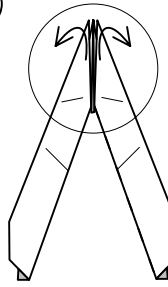

Slide the top layers slightly to the sides (see picture)
Note: model will become 3D.



Turn over

18

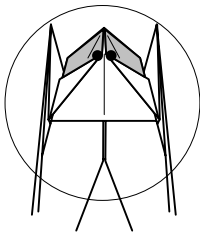
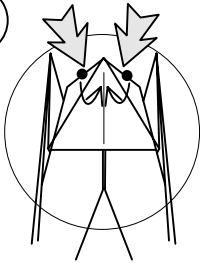

Bring top layer slightly towards the back, exposing some of the color side.

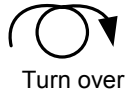

Turn over

19

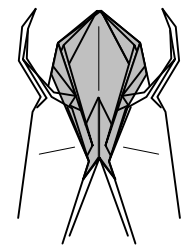
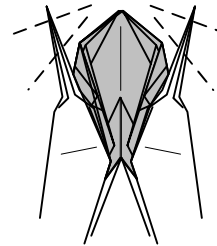
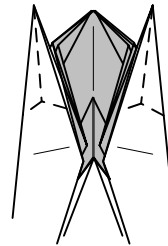

Rabbit ear fold to "thin" the front legs

20

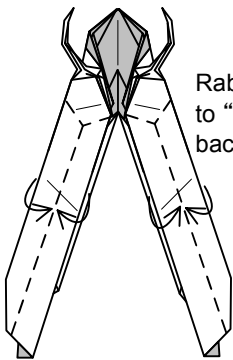

Rabbit ear fold to "thin" the back legs

21

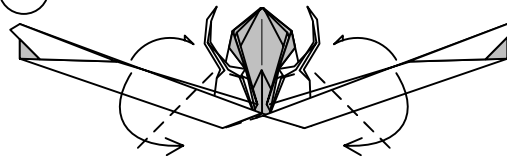

Outside reverse fold

22

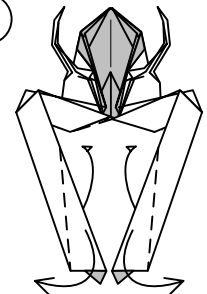

23

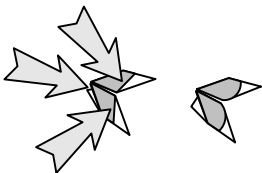

For the details of the eyes, open slightly by rounding it. Open the mouth.

Frog

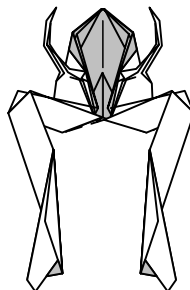

View from bottom

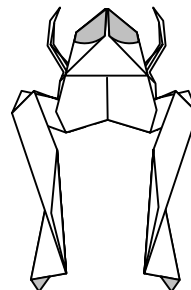

View from top

